



● CVF氣浮式陶瓷真空吸盤特點

- CVF 標準模塊系統，是一個模組化的氣浮平台，專門為平面產品設計之模組，在尺寸上非常節省空間。
- 17種標準模塊，寬度均為80MM，最長尺寸為1200MM。(可接受訂製尺寸)
- 內置兩個氣門迴路，一個為陶瓷氣浮裝置，一個為吸真空裝置

PS:CVF氣浮式陶瓷真空吸盤壓縮空氣壓力建議值為:0.3~2KG，氣浮平台最高可將產品氣浮往上2mm
吸真空壓力為標準吸真空即可

● 用途及適用範圍:

- 適用面板搬運，可夾持無效邊進行搬運動作。
- 適用PCB平板物件搬運。
- 工件高低厚度需1mm以下。

● 外觀尺寸圖 Dimensions

CVF-80x200

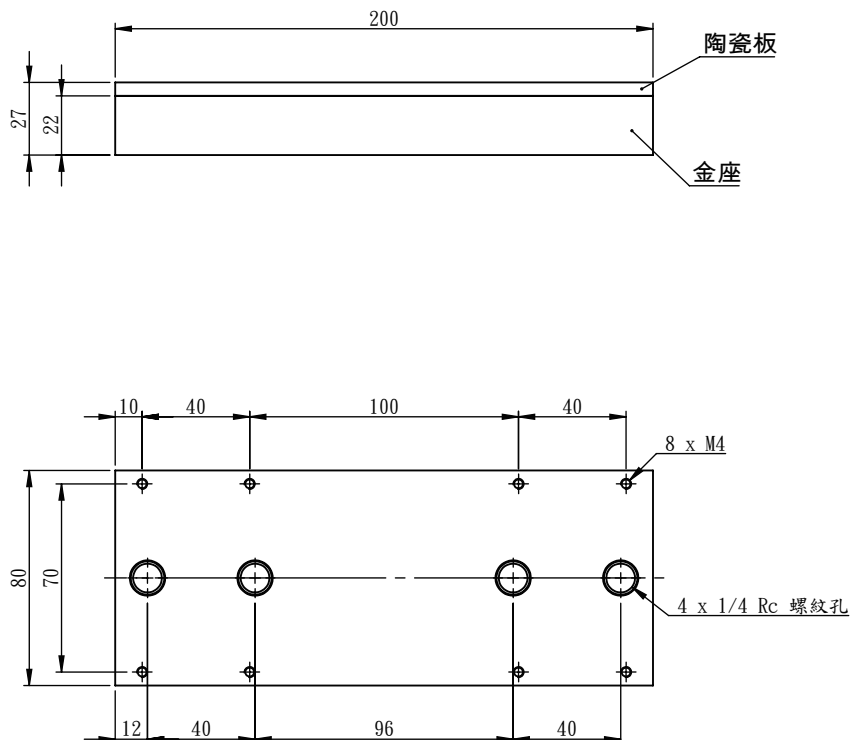

外觀尺寸圖 Dimensions

CVF-80x250

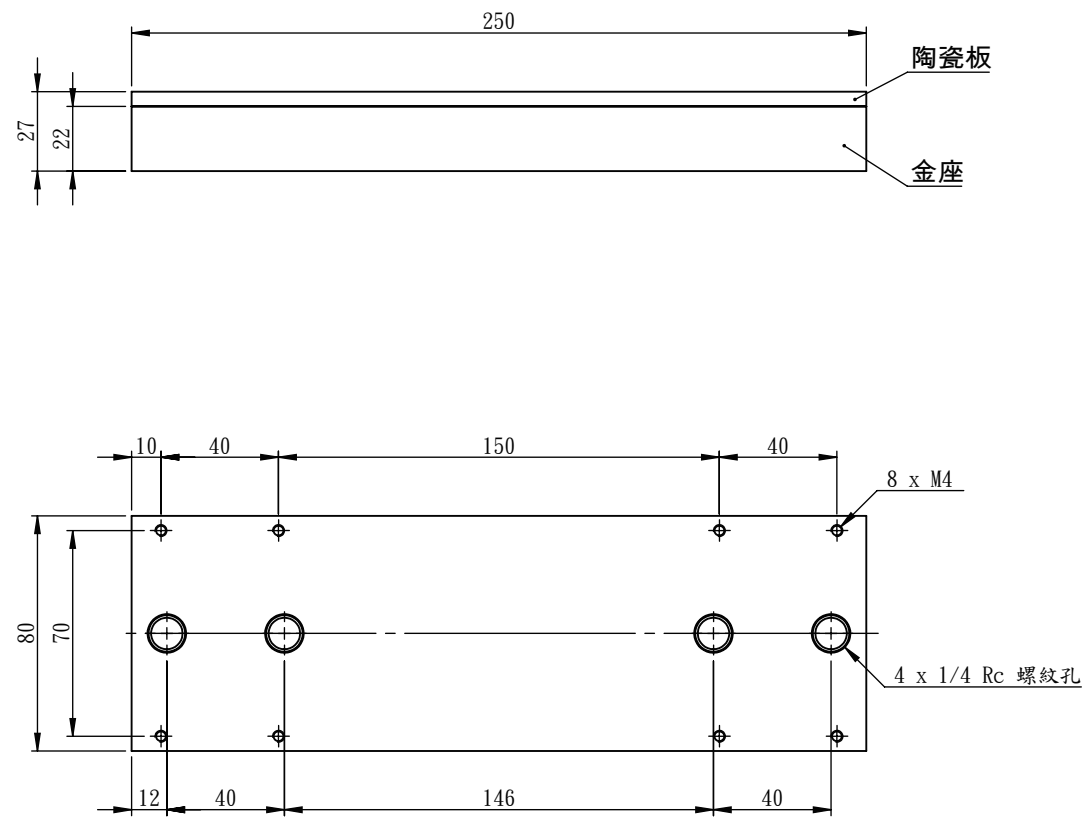

CVF-80x300

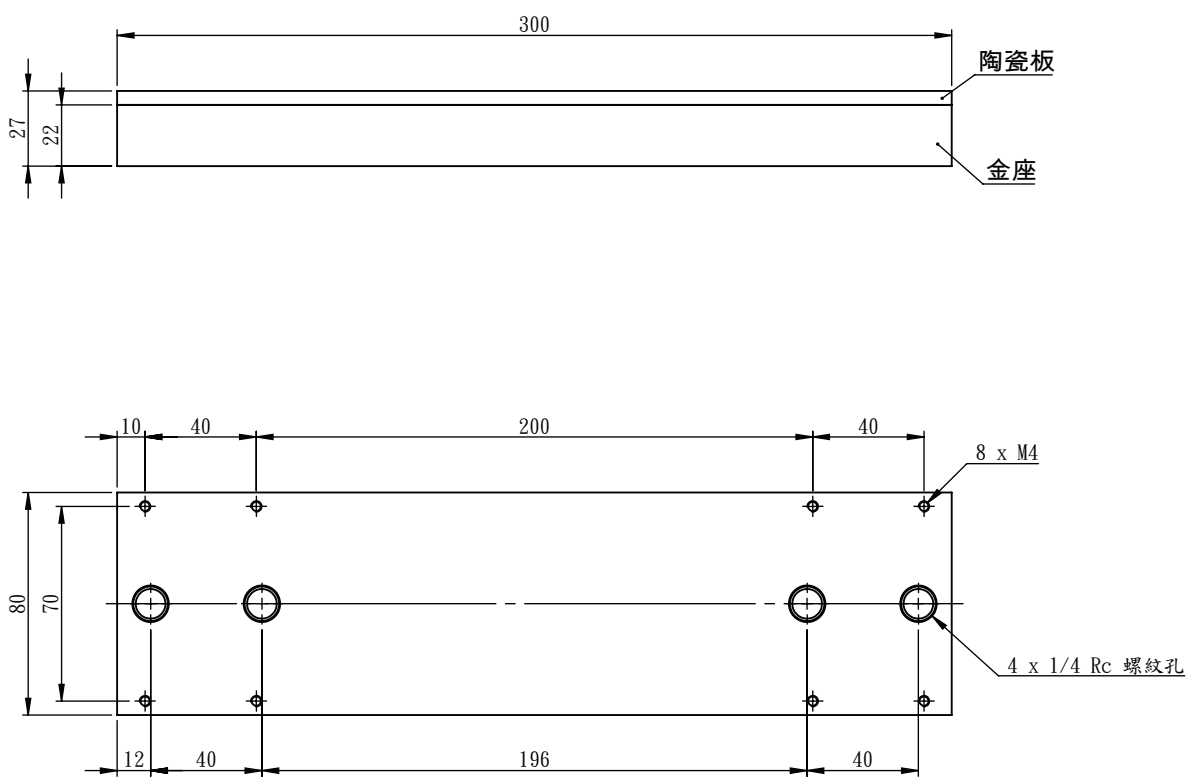

CVF

外觀尺寸圖 Dimensions

CVF-80x350

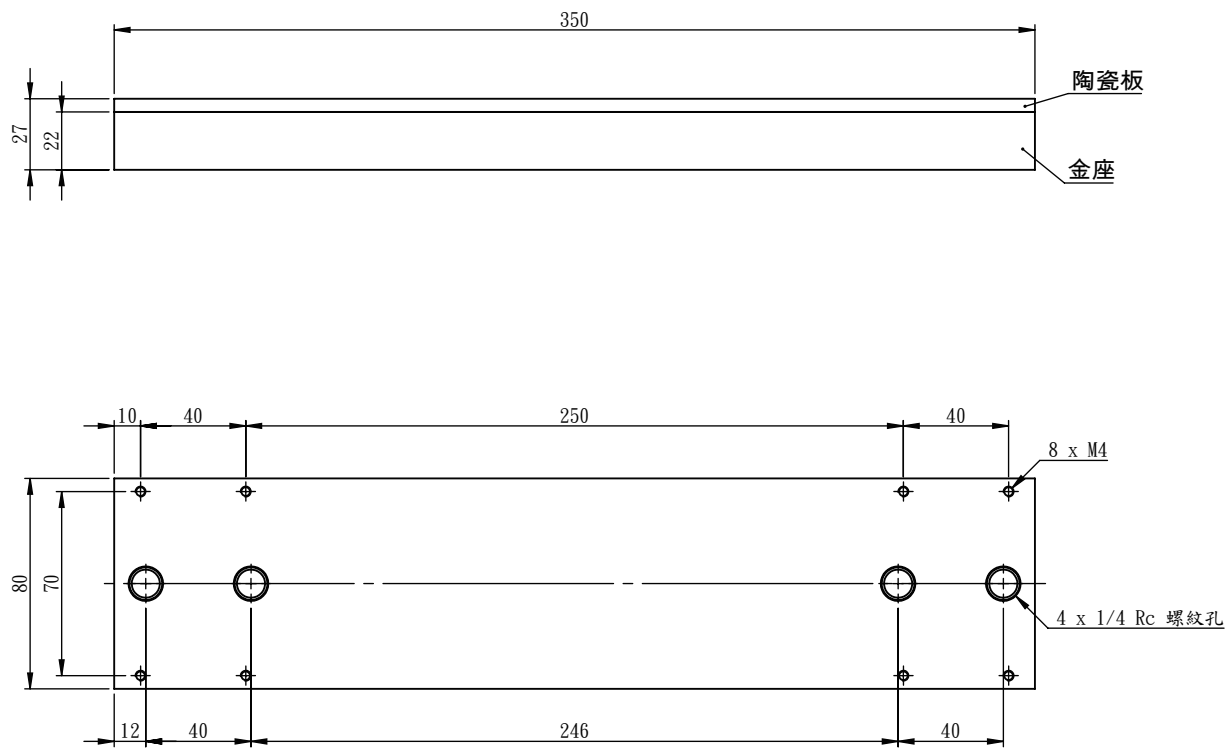

CVF-80x400

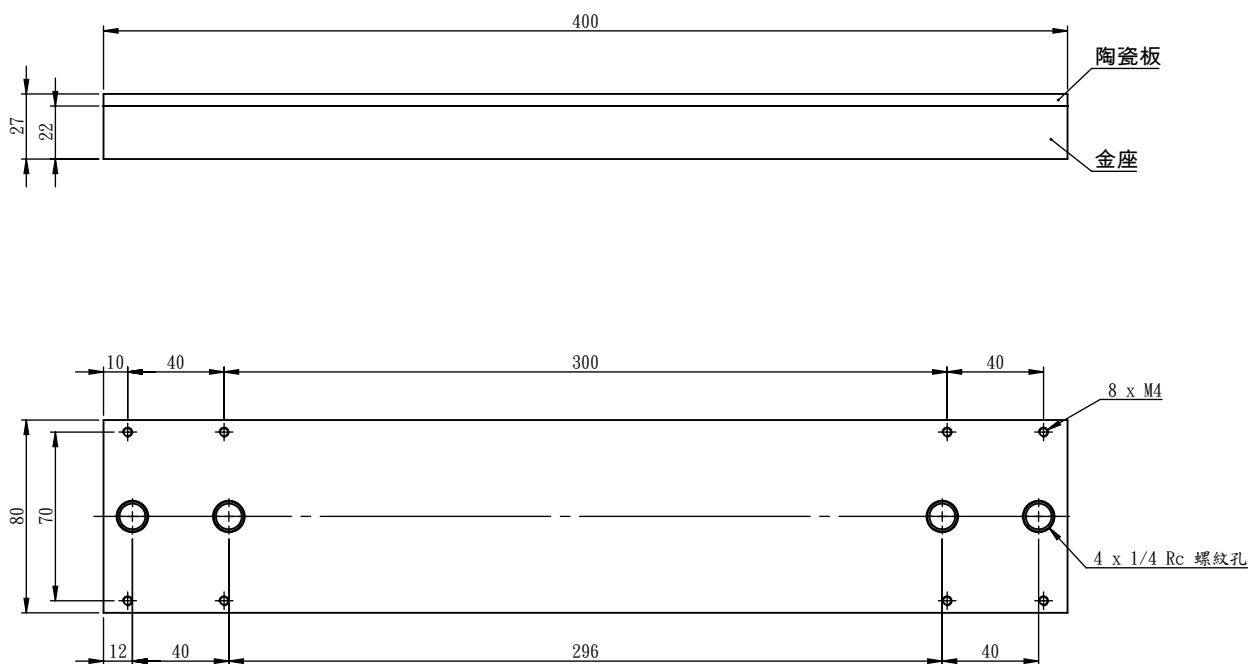

外觀尺寸圖 Dimensions

CVF-80x450

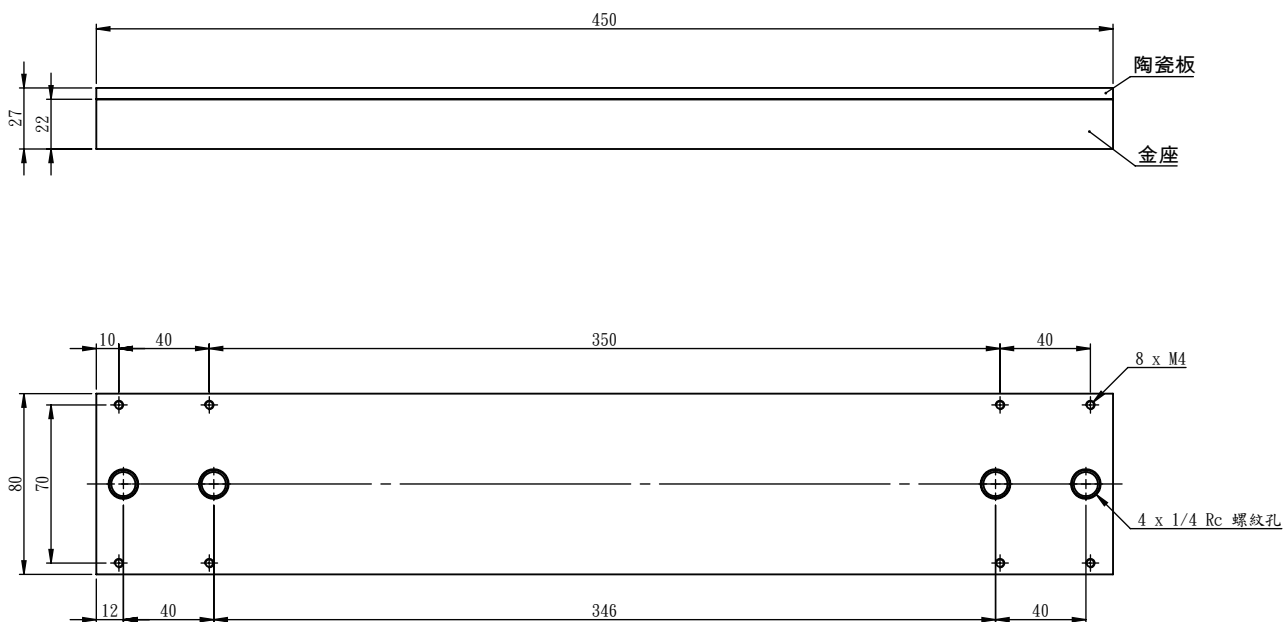

CVF-80x500

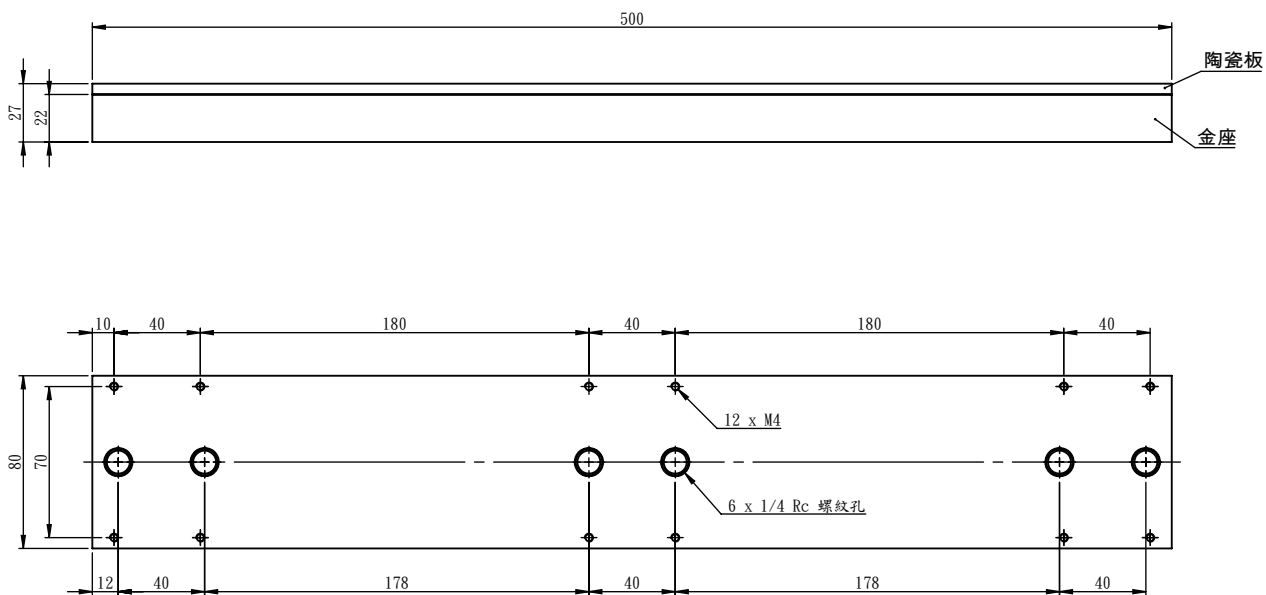

CVF

外觀尺寸圖 Dimensions

CVF-80x600

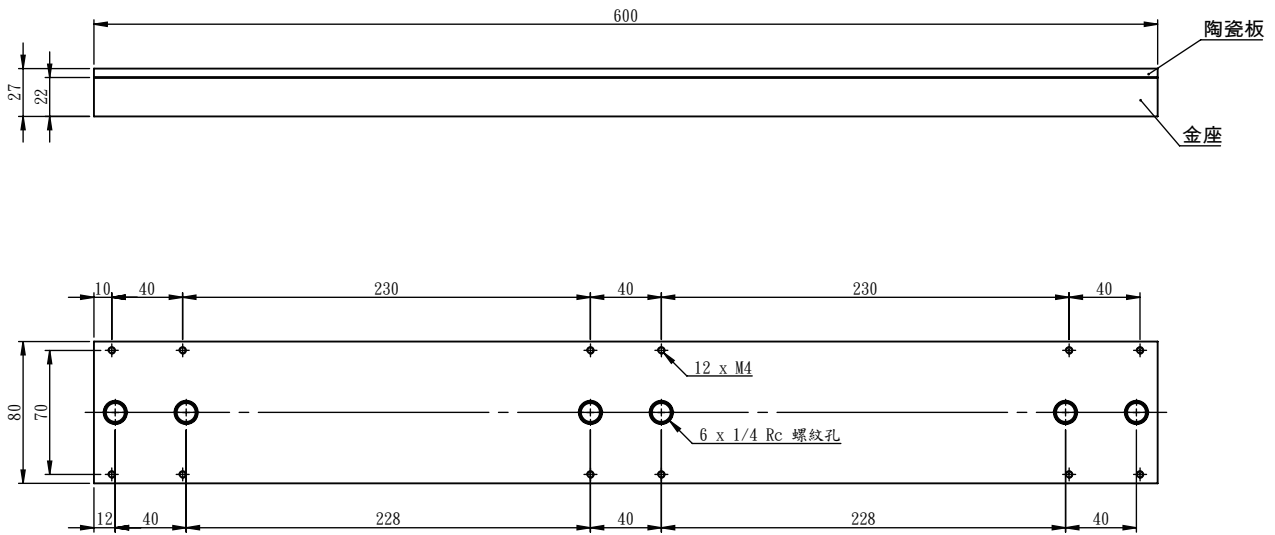

CVF-80x700

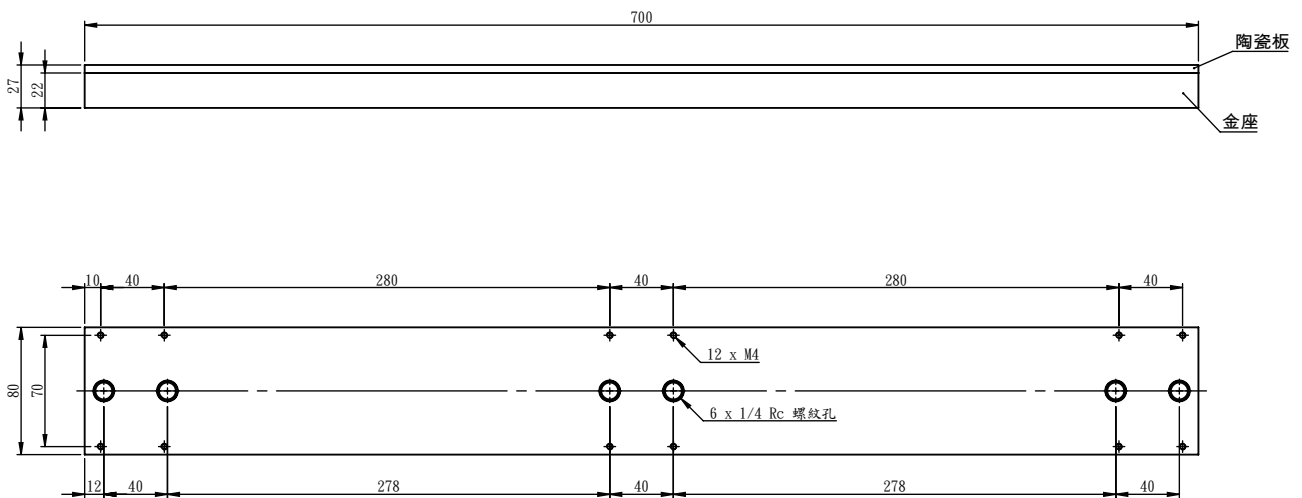

外觀尺寸圖 Dimensions

CVF-80x800

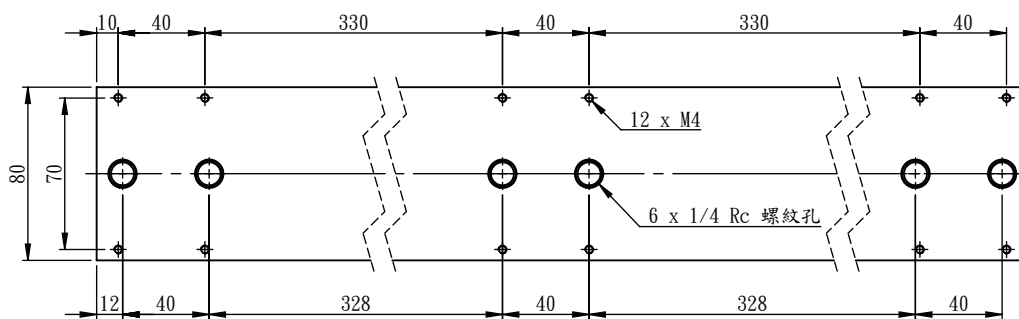
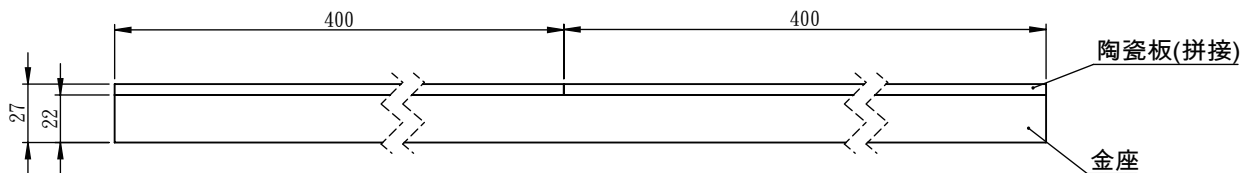

CVF-80x900

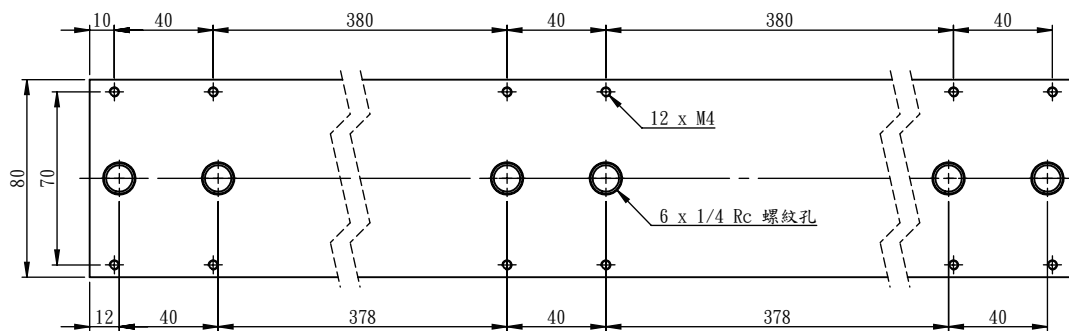
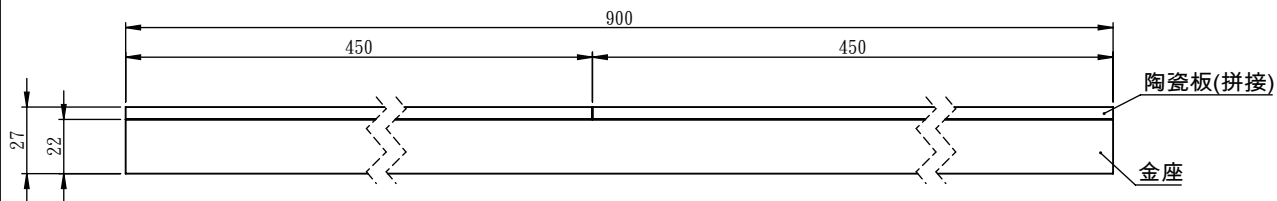

CVF

外觀尺寸圖 Dimensions

CVF-80x1000

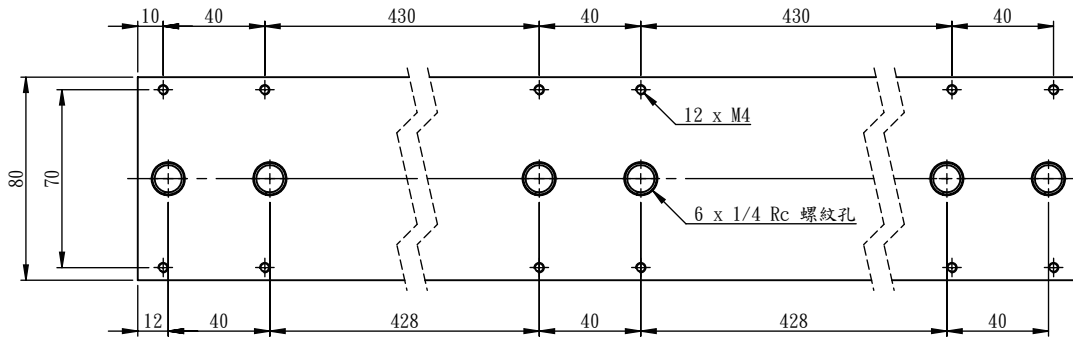
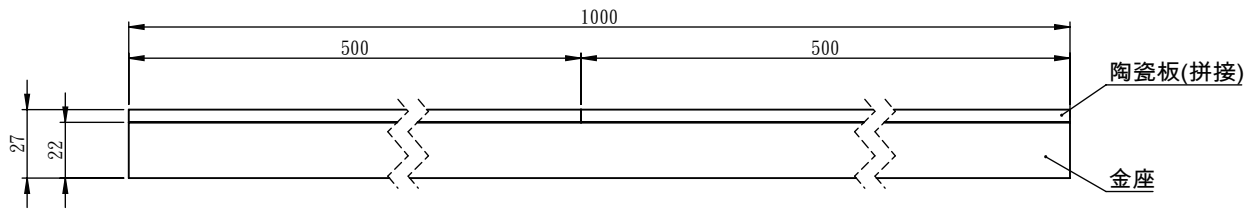

CVF-80x1100

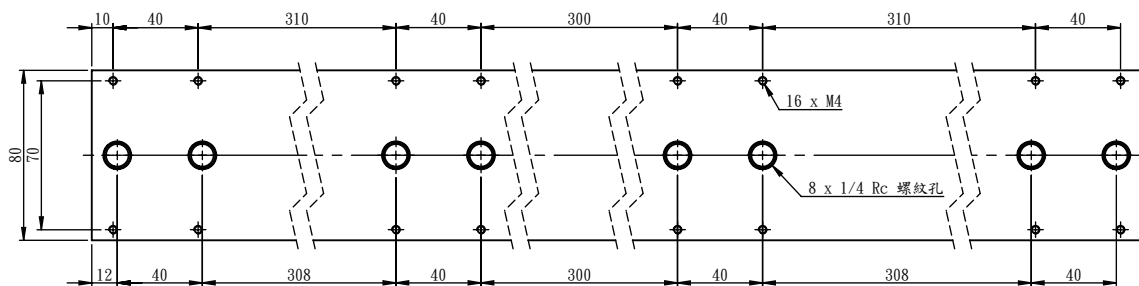
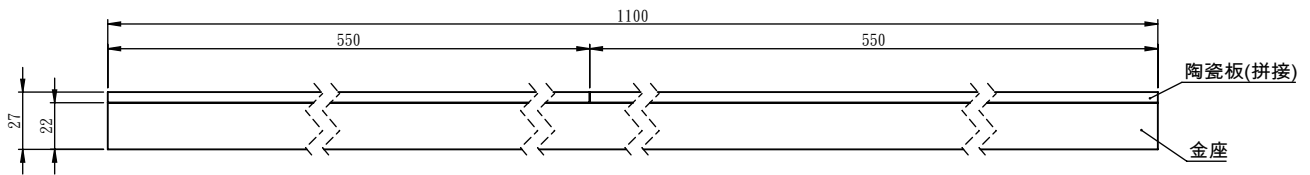

外觀尺寸圖 Dimensions

CVF-80x1200

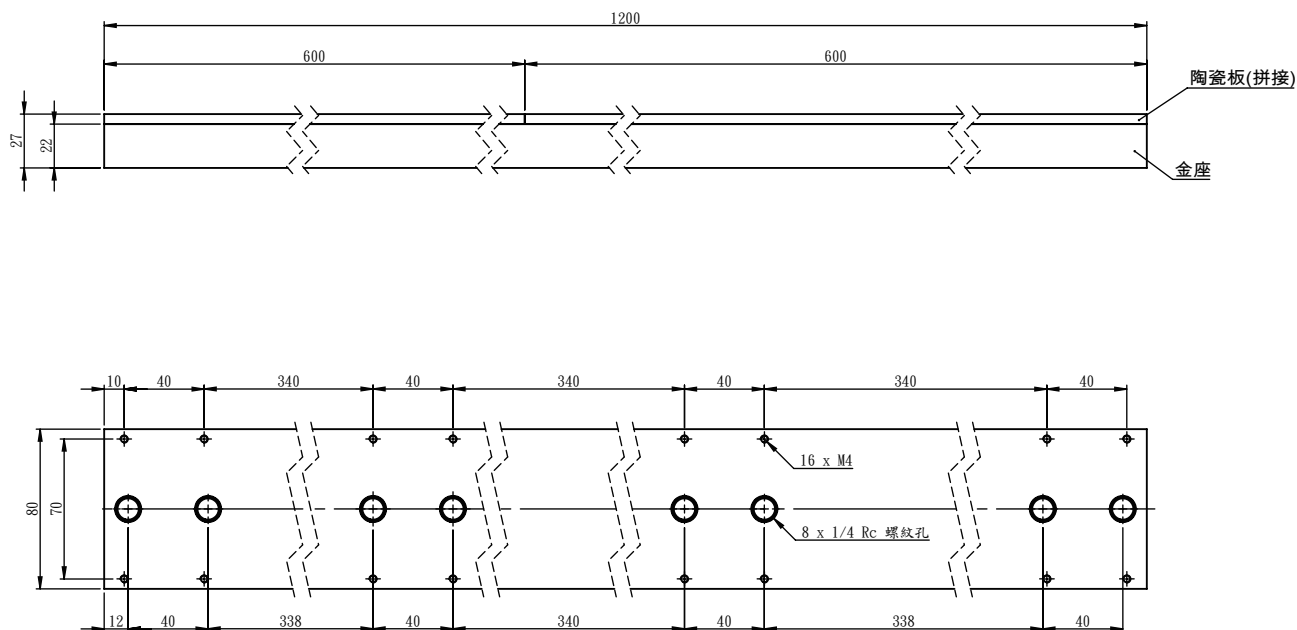

CVF

CVF-FT (CVF專用墊高腳座塊) PS: 一組CVF需要兩個墊高塊

